

### 3 Adjusting the TV

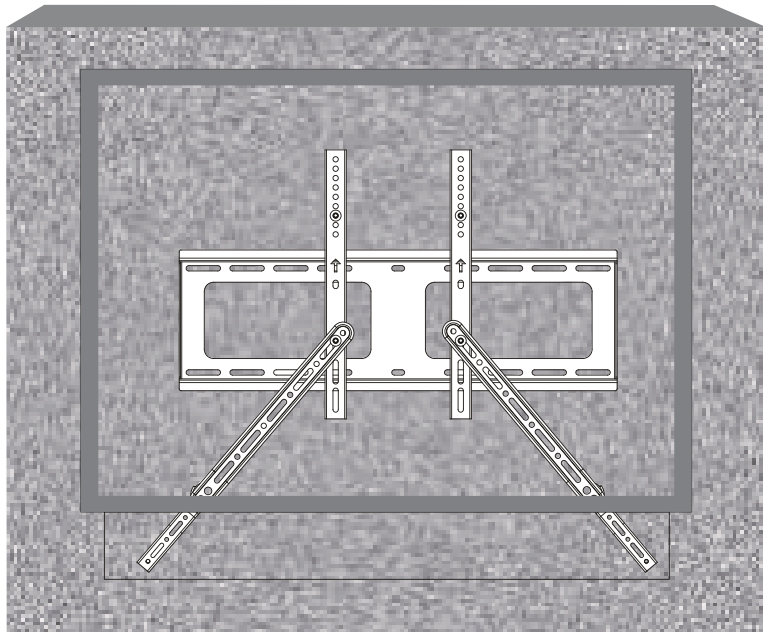









Soundbar brackets will not prevent adjustments to be made. Make adjustments to your TV according to the TV mount features. See TV wall mount manual (not included) for instructions.

### Maintenance

Please check that the wall mount is secure and safe to use at regular intervals. If you have any questions regarding any of the instructions or warnings; please contact your local distributor (OR) contact QualGear technical support via email at [support@qualgear.com](mailto:support@qualgear.com).

Scan the QR Code™ below to contact us:



- |   |   |
|---|---|
|  +1 (972) 423-8960   |  <a href="mailto:support@qualgear.com">support@qualgear.com</a>  |
|  <a href="https://facebook.com/qualgear">facebook.com/qualgear</a>         |  <a href="https://youtube.com/qualgear">youtube.com/qualgear</a> |
|  <a href="https://twitter.com/qualgear">twitter.com/qualgear</a>           |  <a href="https://store.qualgear.com">store.qualgear.com</a>     |
|  <a href="https://pinterest.com/qualgearusa">pinterest.com/qualgearusa</a> |  <a href="https://google.com/+qualgear">google.com/+qualgear</a> |

**QualGear**  
Accessories that Inspire.

**QG-SB-001-BLK**  
INSTALLATION MANUAL

## UNIVERSAL SOUNDBAR BRACKETS

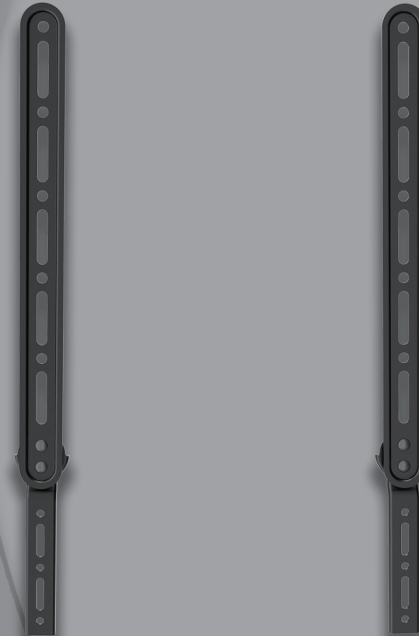

Scan the QR Code™ below for more info about this product:



65" MAX

Works with most 23" to 65" Flat Screen TVs

15kg  
(33lbs)  
RATED

#### CAUTION!

Do not exceed the maximum rated weight specified. Otherwise, serious injury or property damage may occur.



#### VESA

75x75 | 100x100 | 200x100 | 200x200  
300x300 | 400x200 | 400x400 | 600x400

■ 1 Year Limited Warranty

■ Version May 2019

**NOTE**

Please read the entire installation manual. Check to ensure that all parts are included before you start installation and assembly.

## ! WARNING

- Do not begin to install your QualGear product until you have read and understood all the instructions and warnings contained in this installation manual. If you have any questions regarding the instructions, for US customers please contact QualGear customer support via email at [support@qualgear.com](mailto:support@qualgear.com). For all international customers, please contact your local distributor.
- This product should only be installed by someone of good mechanical aptitude, has experience with basic building construction, and fully understands these instructions.
- This product was designed to be installed and utilized only as specified in this manual. Improper installation of this product may cause damage or serious injury. QualGear is not liable for the improper use or installation of its products.
- Make sure that the supporting surface will safely support the combined load of the equipment and all attached hardware and components.
- Always use an assistant or mechanical lifting equipment to safely lift and position the equipment.
- Tighten screws firmly, but do not over tighten. Over tightening can damage the items, greatly reducing their holding power.
- All QualGear products are intended for indoor use only and any outdoor use voids the limited warranty.
- All QualGear products are designed and tested for residential use only and any commercial use voids the limited warranty. For warranty information, please visit <http://www.qualgear.com/warranty.php>.
- Never exceed the maximum rated weight specified in this manual.
- All bolts and screws must be used at the designated points in the installation instructions to prevent property damage and/or personal injury.
- DO NOT install near air conditioner vents or where there is excessive dust or smoke.

## Parts Checklist



**IMPORTANT:** Before starting installation, please check that all parts shown in this checklist are included. If any parts are missing or damaged, contact your local distributor or [support@qualgear.com](mailto:support@qualgear.com) for replacement parts and do not start assembly and installation until you receive all the parts.

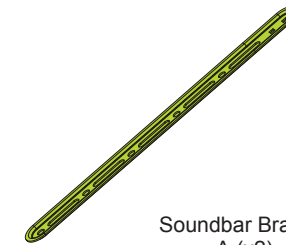

Soundbar Bracket  
A (x2)

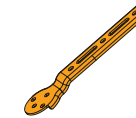

Extension Arms  
B (x2)



M6x10 Screw (x4)  
C



M6 Nut (x4)  
D

## Hardware Package



M4x14 (x2)  
E



M5x14 (x2)  
F



M6x14 (x2)  
G



D5 Washer(x2)  
H



M6x14 (x2)  
I



M6 (x2)  
J



M6x14 (x4)  
K

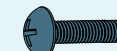

M6x20 (x4)  
L

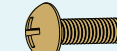

M8x20 (x4)  
M

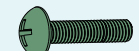

M6x30 (x4)  
N

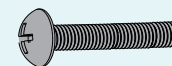

M8x50 (x4)  
O



5mm Small Spacer (x8)  
P



15mm Large Spacer (x8)  
Q

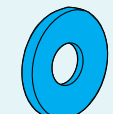

Plastic Washer (x2)  
R

## 1a For Smaller Soundbar Installation

### Attaching the Soundbar Brackets to the Soundbar

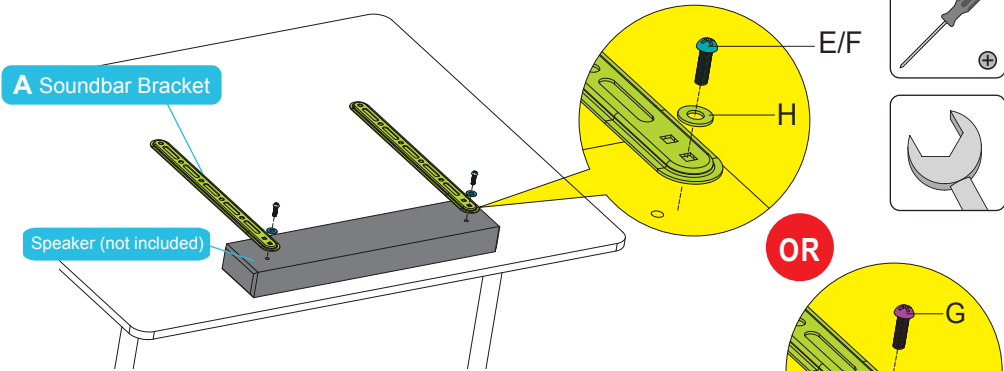

Choose the appropriate screws and washers (if necessary) according to the type of your soundbar. Screw the soundbar brackets onto the soundbar.



If your soundbar has **teardrop** holes on the back, attach the appropriate screws and nuts to the soundbar brackets. Hang the soundbar on the screws, making sure the screw heads fit properly in the soundbar's **teardrop** holes.

**NOTE** Soundbar brackets are designed to be sandwiched in between the back of the TV and the wall mount bracket.

1

### Adjusting the Soundbar Brackets on the Back of the TV

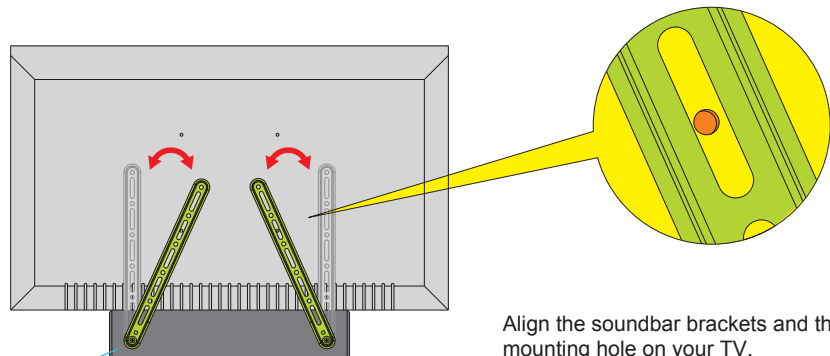

Align the soundbar brackets and the mounting hole on your TV.

2

## Attaching the Wall Mount Brackets to the TV and to the Soundbar Brackets

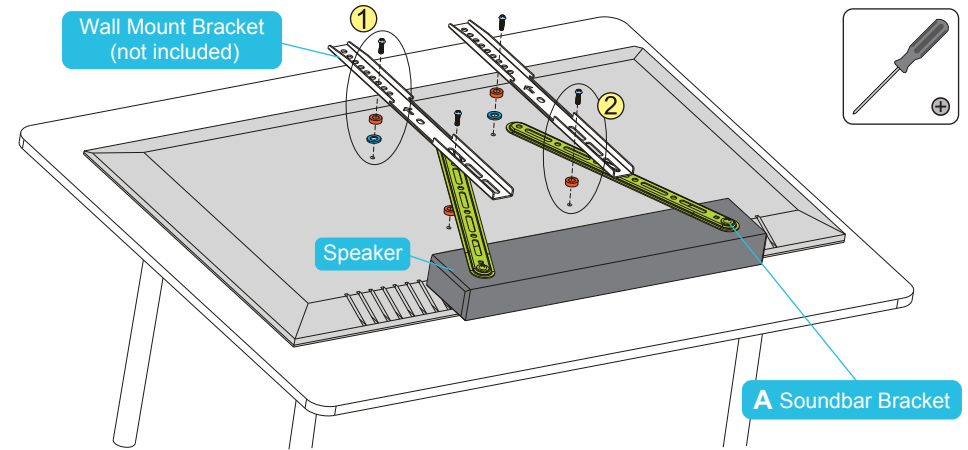

Choose the appropriate screws, washers, and spacers (if necessary) according to the type of your TV. Attach the wall mount brackets to the mounting holes on the back of the TV and to the soundbar brackets. See illustrations on page 4 & 5.

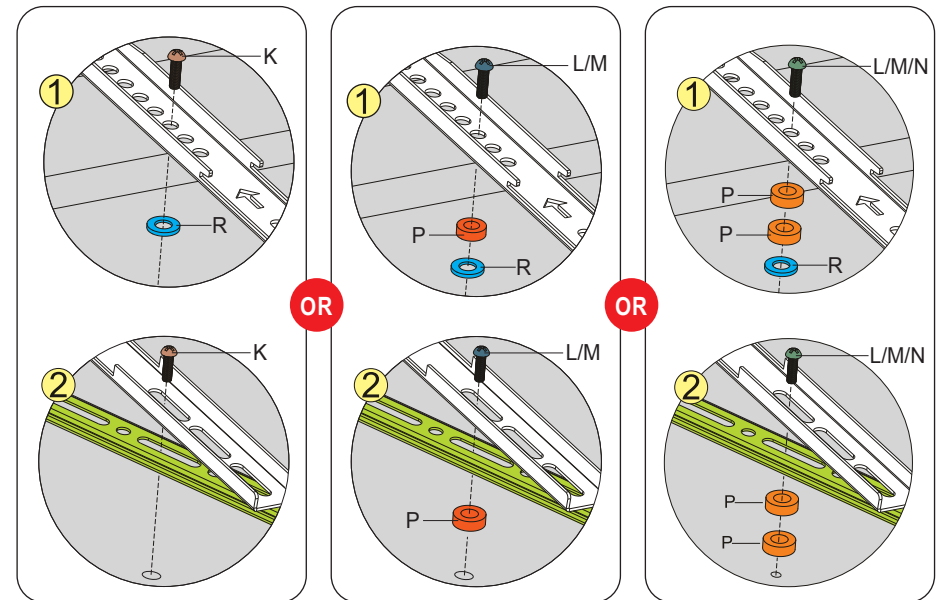

3

**CONTINUE >**



**IMPORTANT!** Tighten all screws but do NOT over tighten

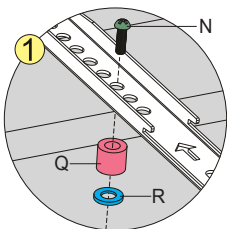

OR

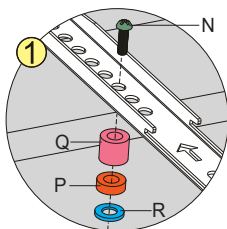

OR

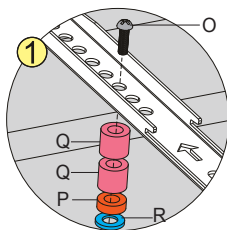
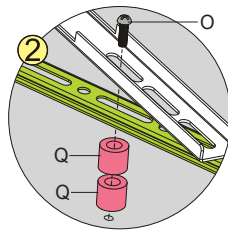
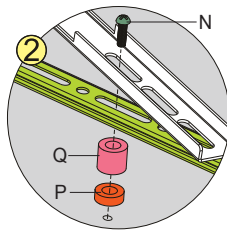
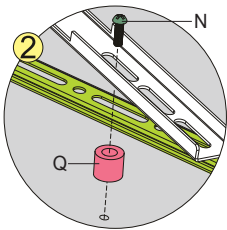
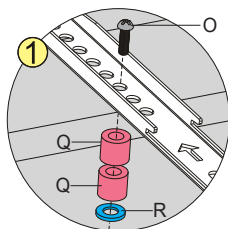

OR

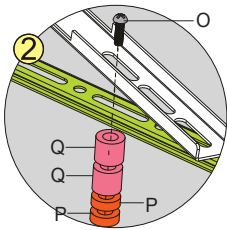
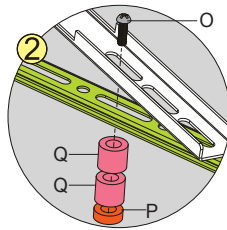
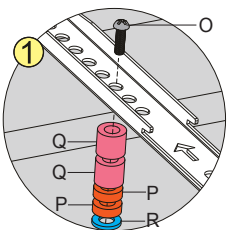

3

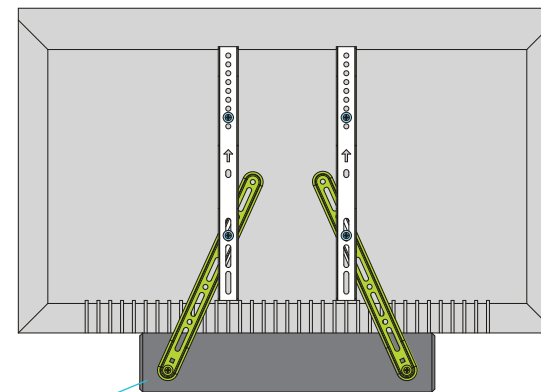

Speaker (not included)

### 1b For Larger Soundbar Installation

#### Attaching the Extension Arms to the Soundbar Bracket



B Extension Arms

Use the appropriate screws and nuts to connect the soundbar brackets to the extension arms.

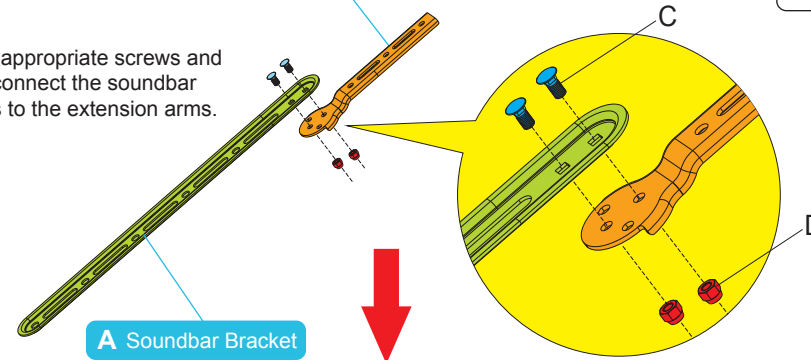

A Soundbar Bracket

Choose one of the configurations below according to the mounting holes on your TV.

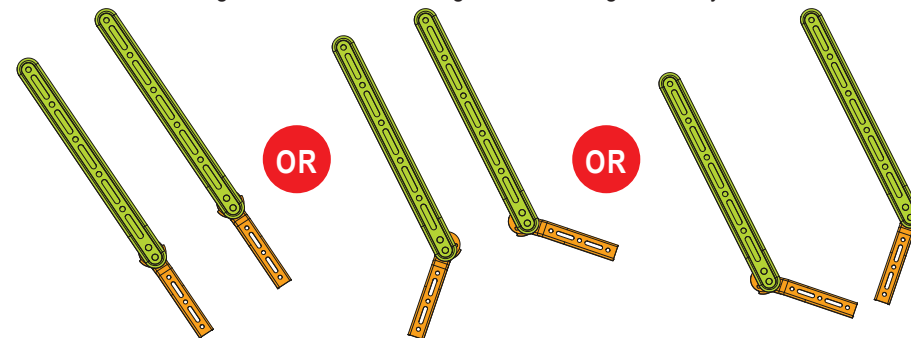

1

## Attaching the Soundbar Brackets to the Soundbar

Choose the appropriate screws and washers (if necessary) according to the type of your soundbar. Screw the soundbar brackets onto the soundbar.

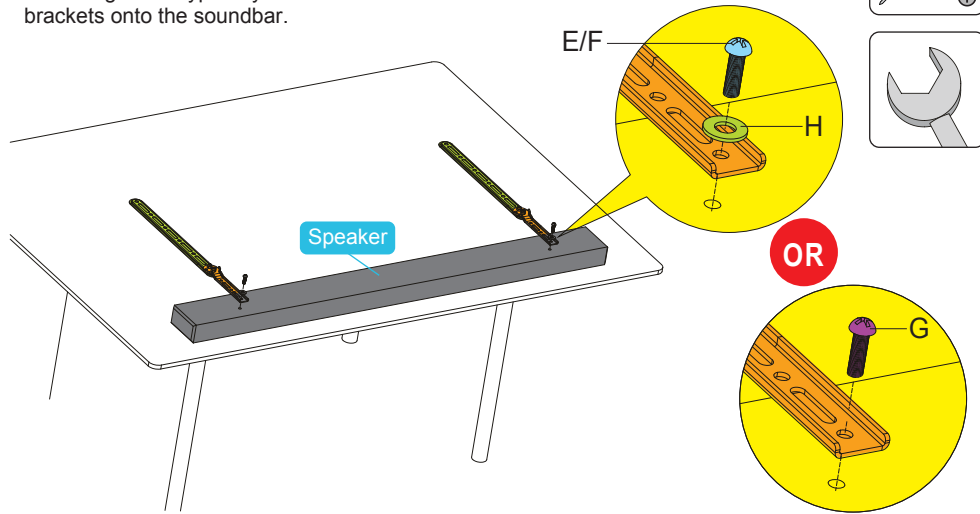

OR

If your soundbar has **teardrop** holes on the back, attach the appropriate screws and nuts to the soundbar brackets. Hang the soundbar on the screws, making sure the screw heads fit properly in the soundbar's **teardrop** holes.

**NOTE** Soundbar brackets are designed to be sandwiched in between the back of the TV and the wall mount bracket.

2

## Place and Adjust the Soundbar Brackets to the Back of the TV

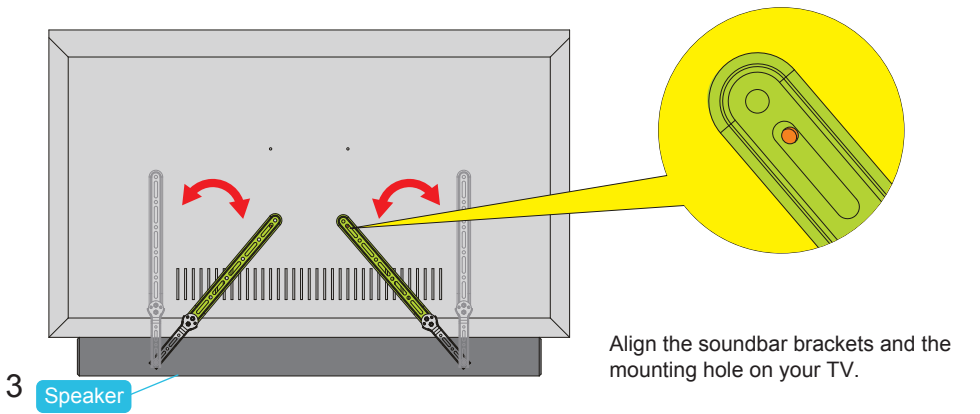

3

## Attaching the Wall Mount Brackets to the TV and to the Soundbar Brackets

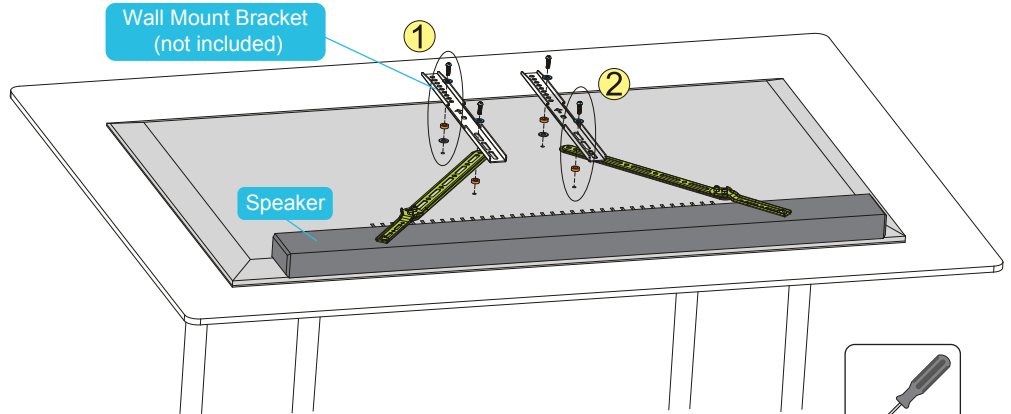

Choose the appropriate screws, washers, and spacers (if necessary) according to the type of your TV. Attach the wall mount brackets to the mounting holes on the back of the TV and to the soundbar brackets. See illustrations on page 8 & 9.

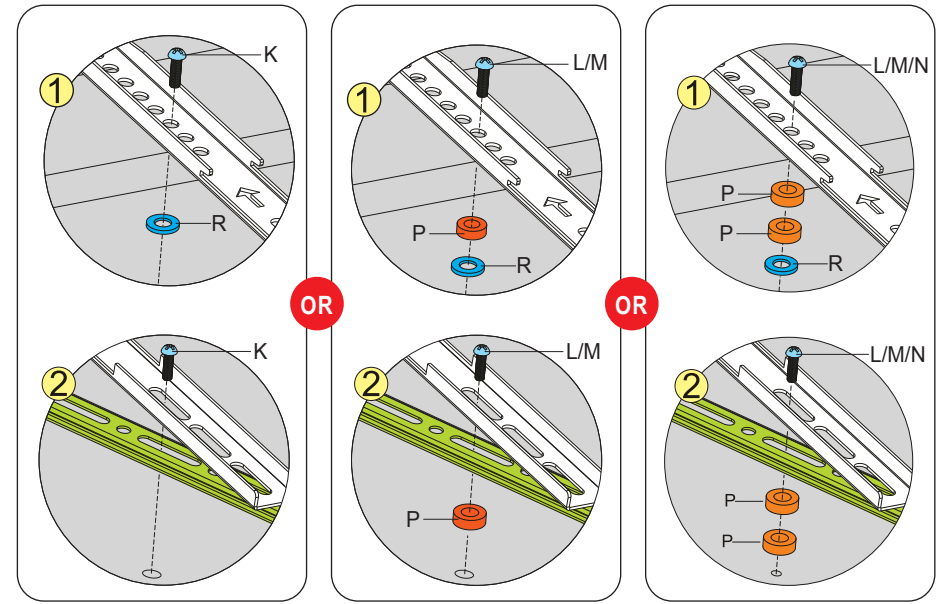

4

**CONTINUE >**

**!** **IMPORTANT!** Tighten all screws but do NOT over tighten

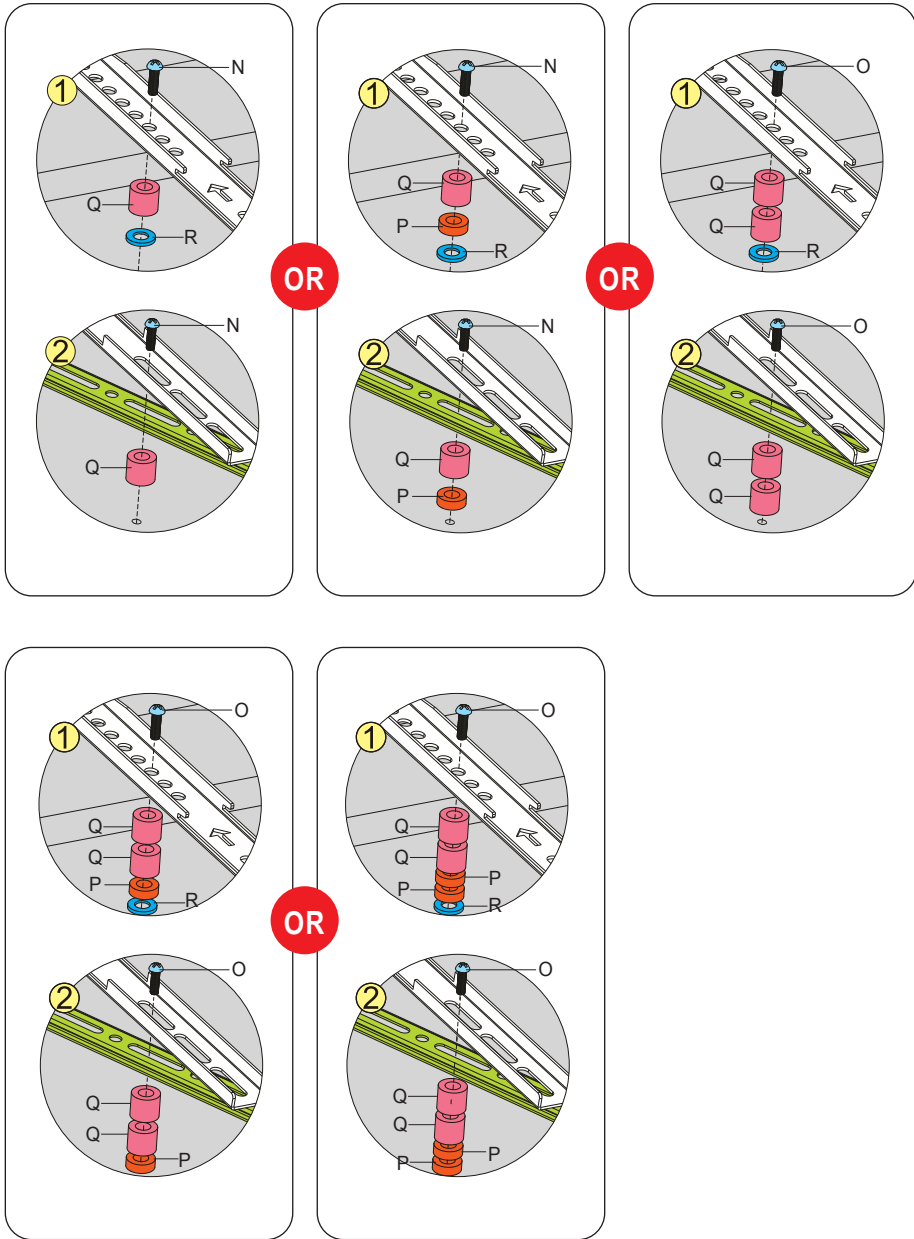

4

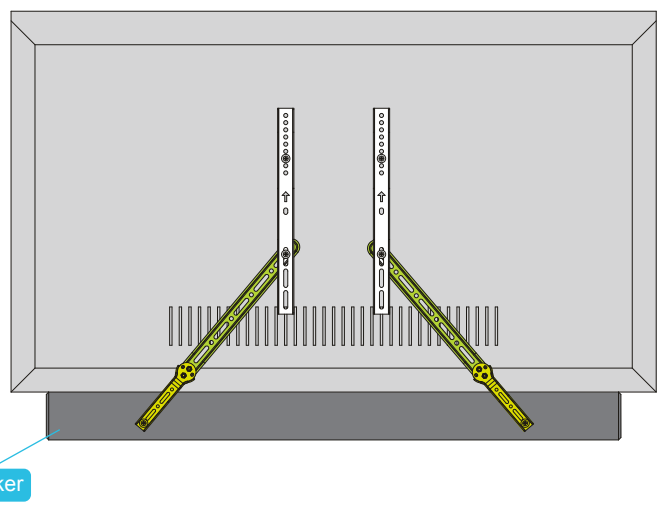

**2** Hanging the TV and Soundbar Assembly onto the Wall Mount

**NOTE** TV wall mount is sold separately. Follow TV wall mount user manual for a safe installation.

**!** **IMPORTANT:** Make sure the TV is safely secured before releasing.

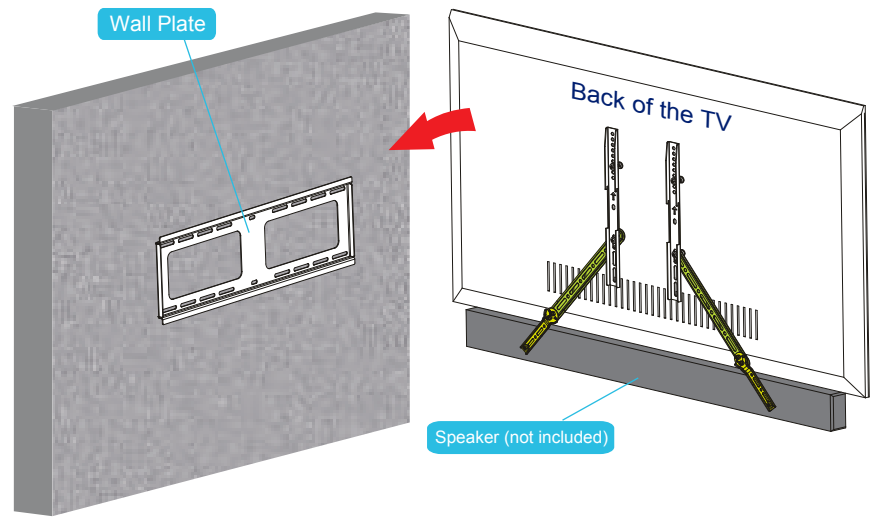

According to your TV wall mount manual, follow the instructions and attach TV and Soundbar Assembly onto the wall plate of your TV wall mount.