

Product Dimensions

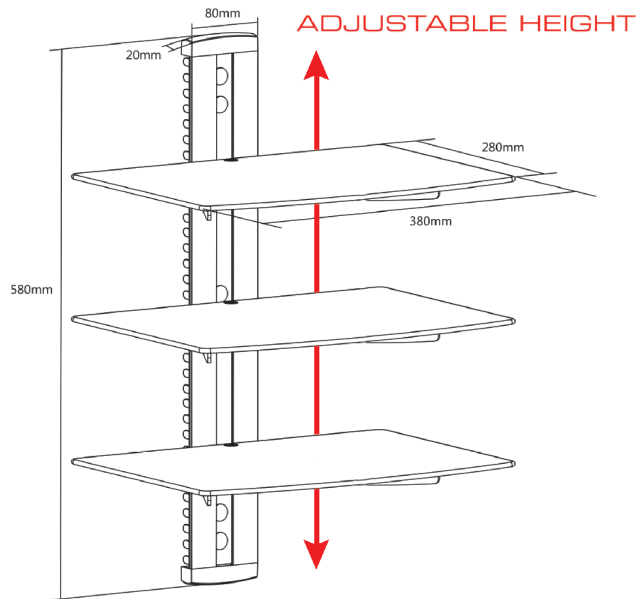









Maintenance

Please check that the wall mount is secure and safe to use at regular intervals. If you have any questions regarding any of the instructions or warnings; please contact your local distributor (OR) contact QualGear technical support via email at support@qualgear.com.

Scan the QR Code™ below to contact us:



- | | |
|---|---|
|  +1 (972) 423-8960 |  support@qualgear.com |
|  facebook.com/qualgear |  youtube.com/qualgear |
|  twitter.com/qualgear |  store.qualgear.com |
|  pinterest.com/qualgearusa |  google.com/+qualgear |

QualGear[®]
Accessories that Inspire.

QG-DB-003-BLK
INSTALLATION MANUAL

TRIPLE SHELF WALL MOUNT



Scan the QR Code™ below for more info about this product:



8kgx3
(17.6lbsx3)
RATED

CAUTION!
Do not exceed the maximum rated weight specified. Otherwise, serious injury or property damage may occur.



■ 1 Year Limited Warranty

■ Version September 2013

NOTE

Please read the entire installation manual. Check to ensure that all parts are included before you start installation and assembly.

WARNING

- Do not begin to install your QualGear product until you have read and understood all the instructions and warnings contained in this installation manual. US customers with questions regarding instructions, please contact QualGear customer support via email at support@qualgear.com. For all international customers, please contact your local distributor.
- This product should only be installed by someone of good mechanical aptitude, has experience with basic building construction, and fully understands these instructions.
- This product was designed to be installed and utilized only as specified in this manual. Improper installation of this product may cause damage or serious injury. QualGear is not liable for the improper use or installation of its products.
- Make sure that the supporting surface will safely support the combined load of the equipment and all attached hardware and components.
- Always use an assistant or mechanical lifting equipment to safely lift and position the equipment.
- Tighten screws firmly, but do not over tighten. Over tightening can damage the items, greatly reducing their holding power.
- All QualGear products are intended for indoor use only and any outdoor use voids the limited warranty.
- All QualGear products are designed and tested for residential use only and any commercial use voids the limited warranty. For warranty information, please visit <http://www.qualgear.com/warranty.php>.
- If mounting to wooden studs, make sure that mounting screws are anchored into the center of the studs. Use of an edge-to-edge stud finder is highly recommended.
- Never exceed the maximum rated weight specified in this manual.
- All bolts and screws must be used at the designated points in the installation instructions to prevent property damage and/or personal injury.
- DO NOT install near air conditioner vents or where there is excessive dust or smoke.
- When drilling holes in the wall, it is very important to take care of electrical cables, water, or gas pipes in the wall.

● This product was designed to be installed on the following wall construction only:

WALL CONSTRUCTION

Wooden Stud
Wooden Beam
Solid Concrete
Other

HARDWARE REQUIRED

Included
Included
Included
Contact Qualified Professional

Parts Checklist



IMPORTANT: Before starting installation, please check that all parts shown in this checklist are included. If any parts are missing or damaged, contact your local distributor or support@qualgear.com for replacement parts and do not start assembly and installation until you receive all the parts.

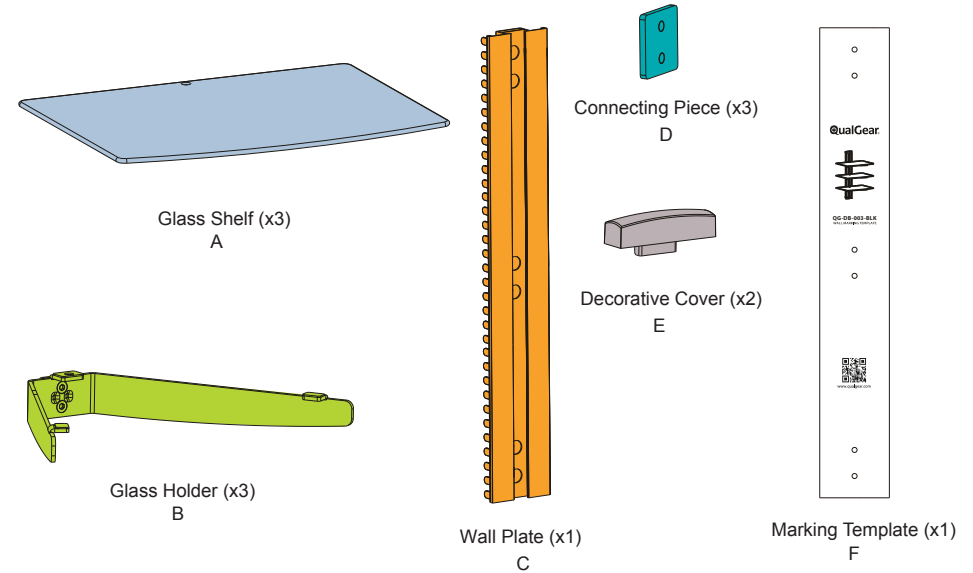

Hardware Package

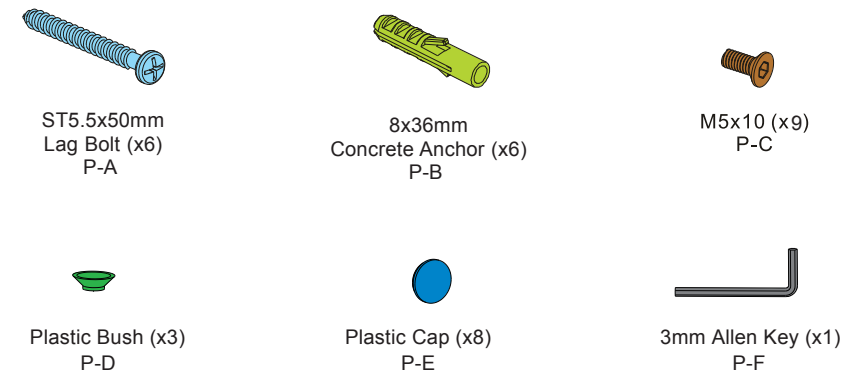

1a Mounting to a Wooden Stud Wall

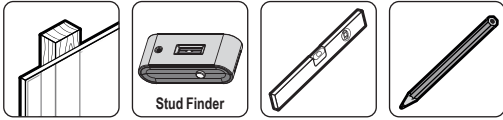

NOTE

For concrete wall mounting, follow Step 1b.

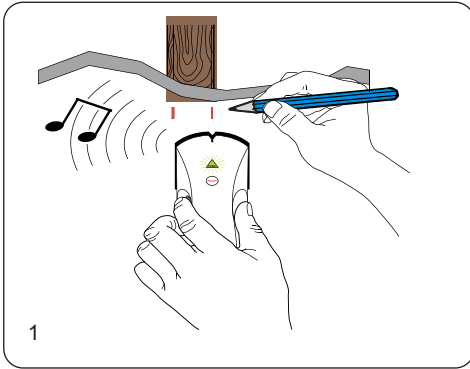

1 Using an edge-to-edge stud finder, find the edges of the stud.

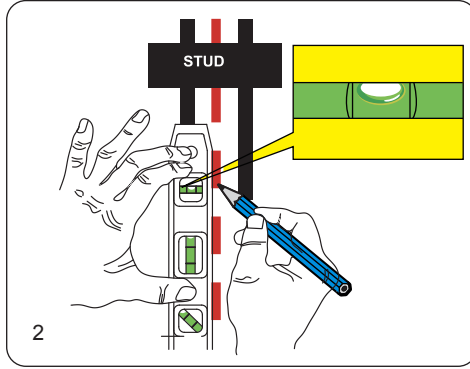

2 Using a level, mark the centerline of the stud.

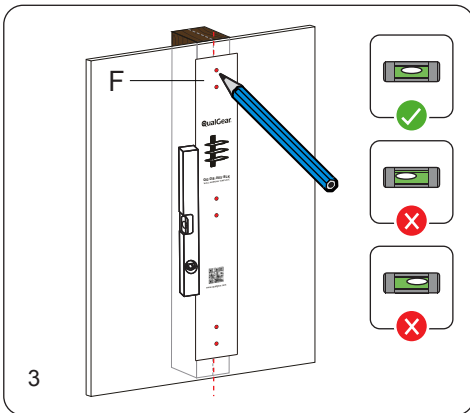

3 Using the marking template (F) provided, mark six holes for drilling on the centerline of the stud.

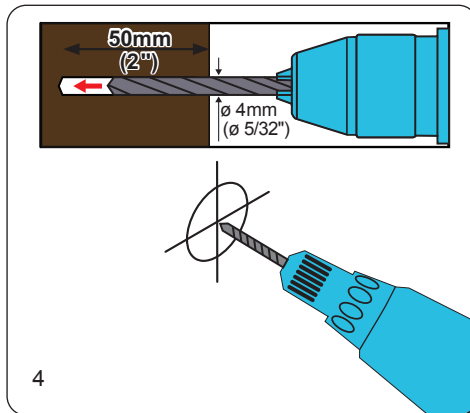

4 Using a power drill and 5/32" drill bit, drill pilot holes of 5/32" (4mm) diameter and at least 2" (50mm) depth.

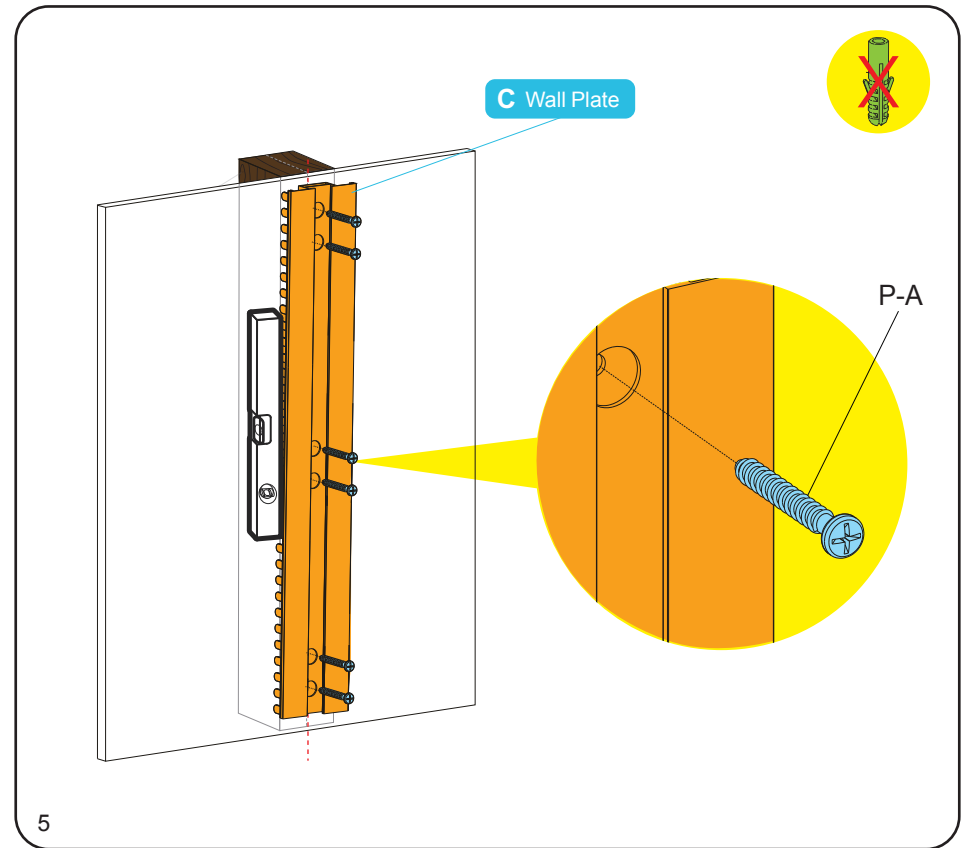

5 Mount the wall plate (C) and tighten it with the provided lag bolts (P-A) using a proper Phillips screwdriver.

NOTE

Do NOT use power drill and do NOT over tighten the lag bolts.

WARNING

- Make sure that mounting screws are anchored into the center of the studs. The use of a stud finder is highly recommended.
- Installers are responsible for providing hardware for other types of mounting situations.
- Installers must verify that the supporting surface will safely support the combined weight of the equipment and all attached hardware and components.

SKIP TO STEP 2 →

1b Mounting to a Concrete Wall

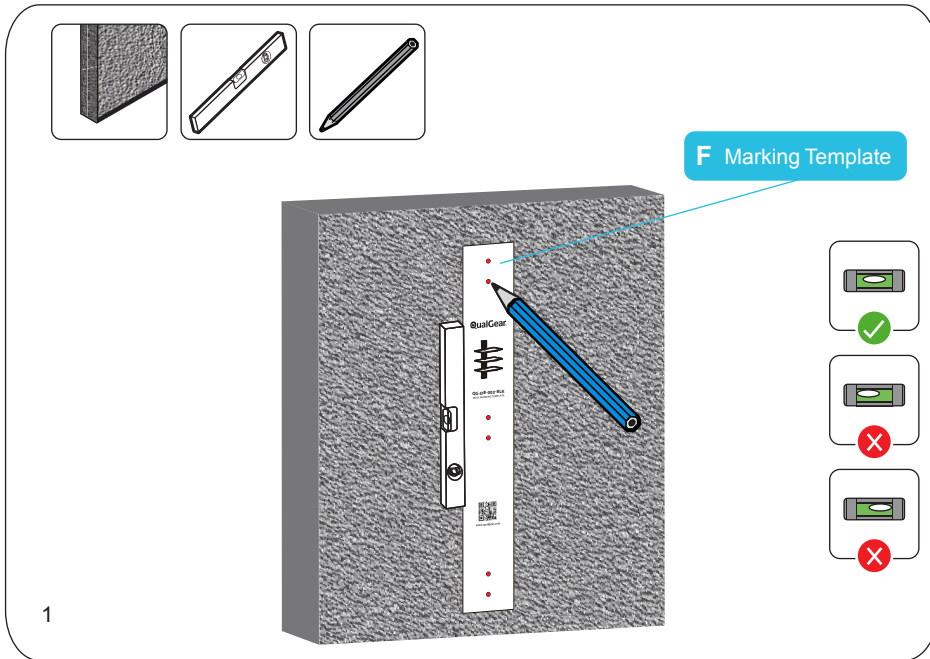

Hold the marking template (F) provided against the wall where you want to install your AV equipment, mark six holes for drilling.

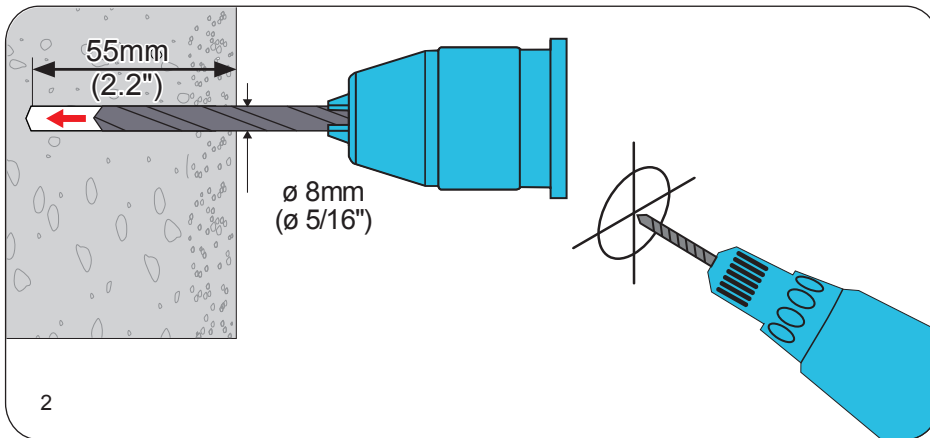

Using a power drill and a 5/16" masonry drill bit, drill mounting holes of 5/16" (8 mm) diameter and 2.2" (55 mm) depth at the marked locations in the previous step.

NOTE Do NOT use power drill and do NOT over tighten the lag bolts.

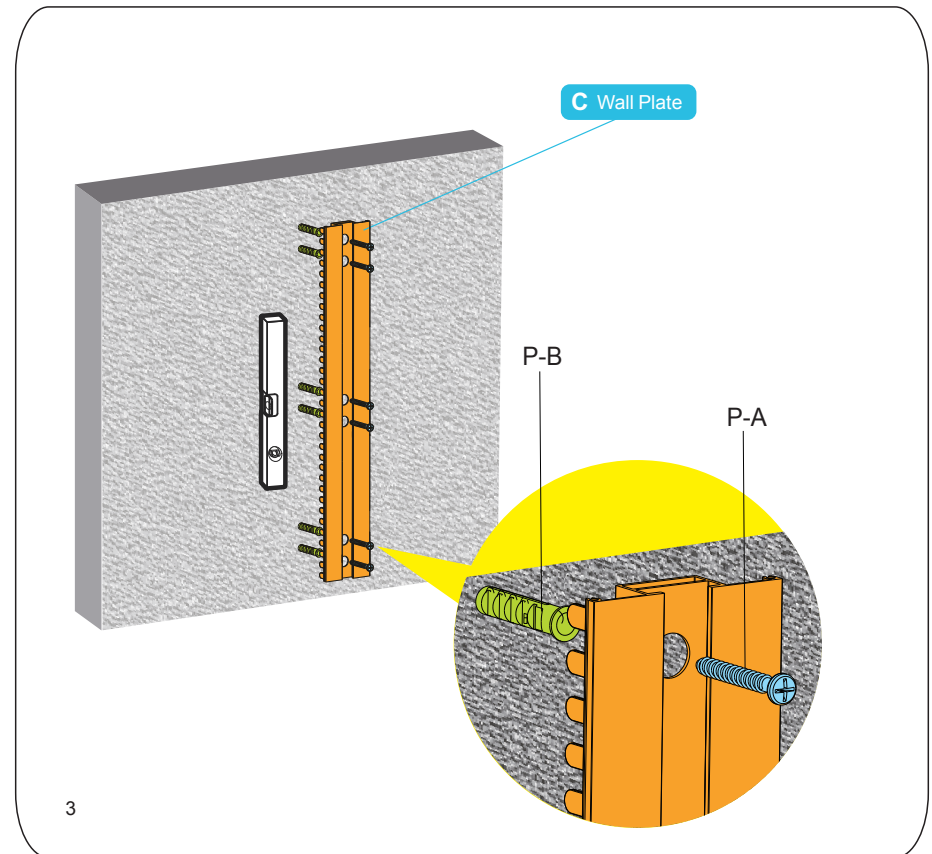

Place concrete anchors (P-B) in each hole. Tap each anchor flush with the wall using a hammer. Using a proper Phillips screwdriver, mount the wall plate (C) and fasten them with the provided lag bolts (P-A).

! WARNING

- Installers must verify that the supporting surface will safely support the combined weight of the equipment and all attached hardware and components.

2 Assembling the Glass Holder and the Connecting Piece

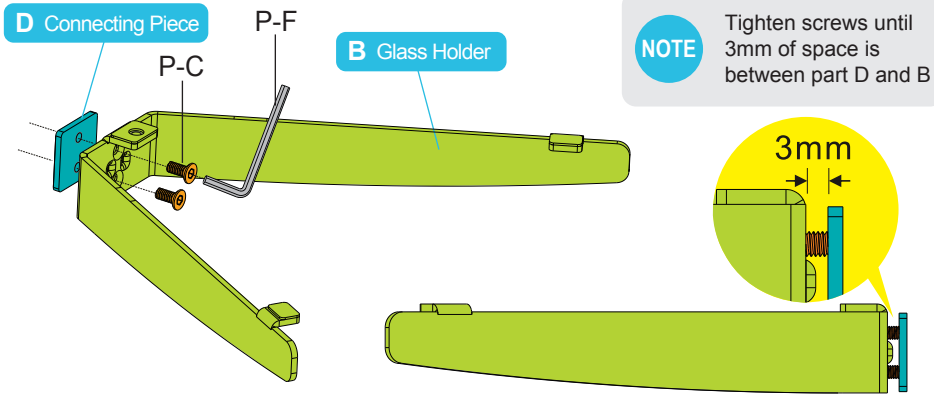

Install the connecting pieces (D) to the glass holders (B).

3 Installing the Glass Holder to the Wall Plate

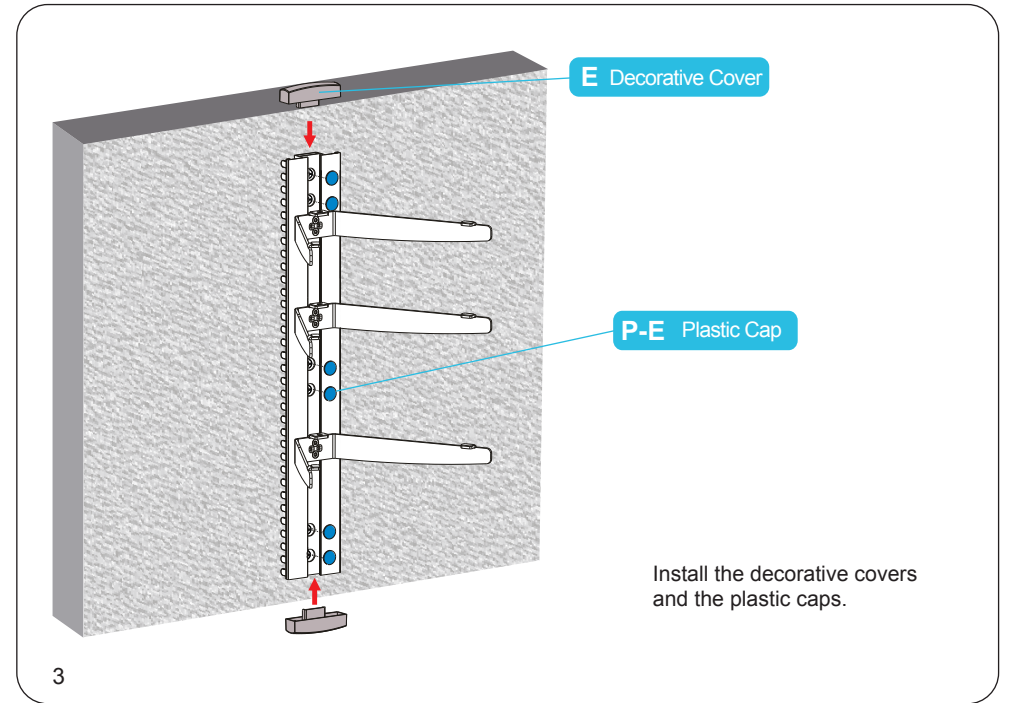
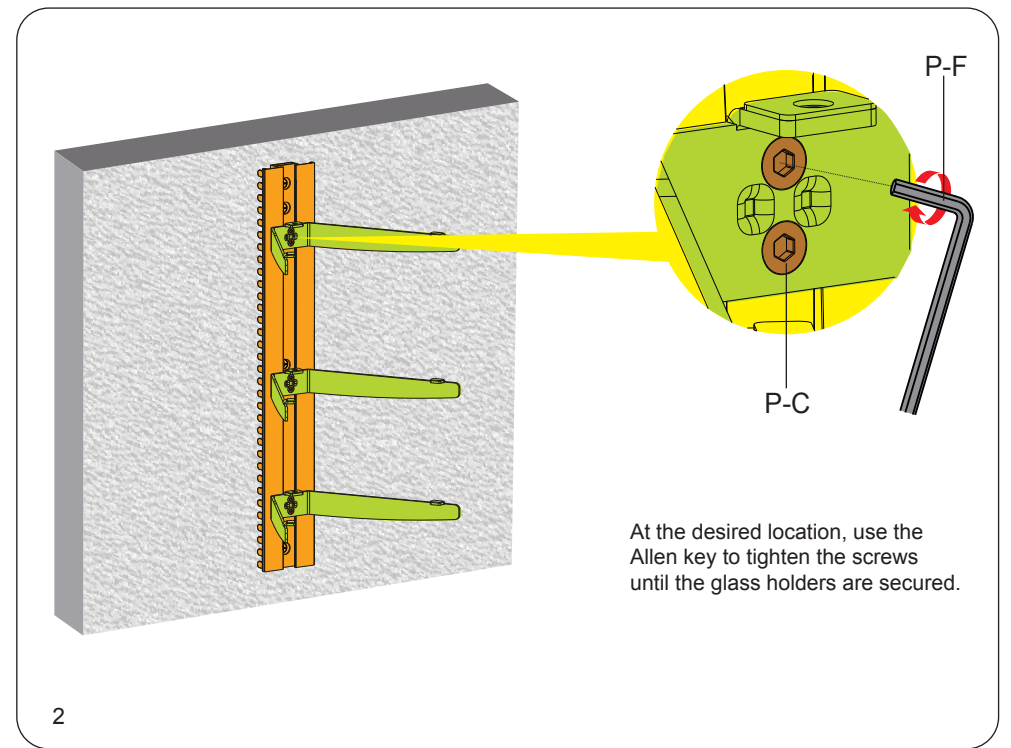
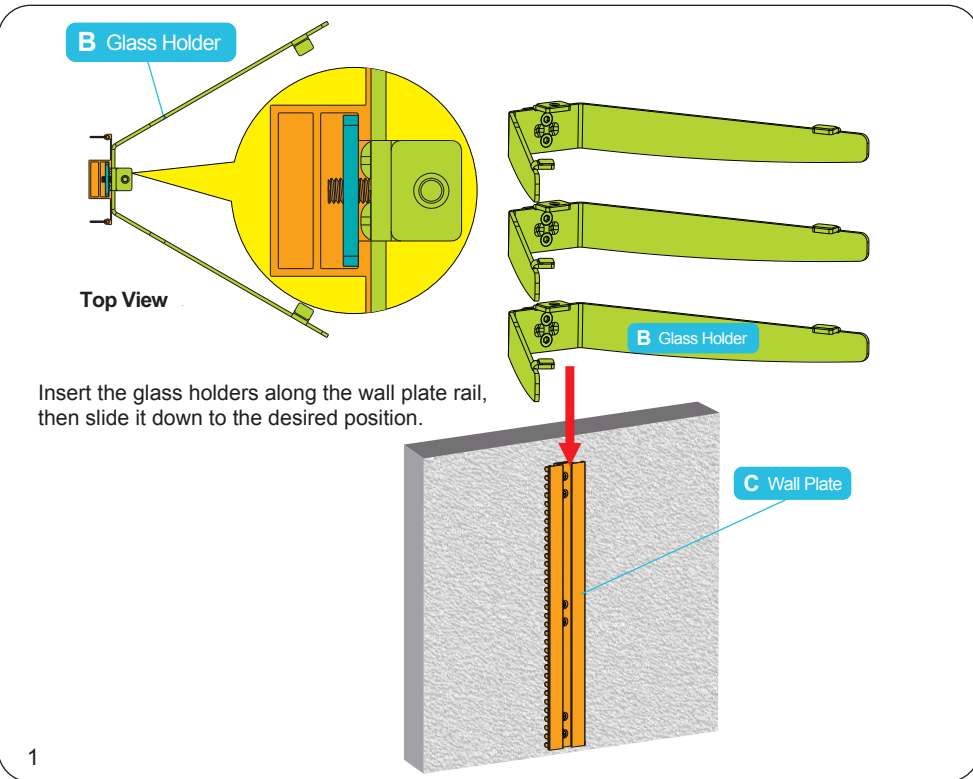

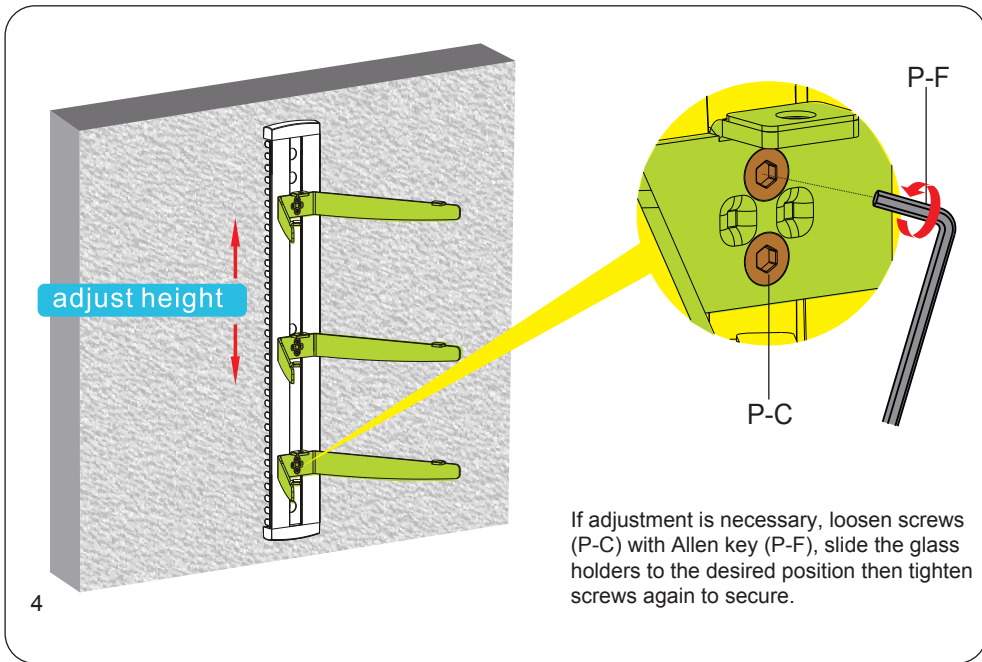

4 Installing the Glass Shelves

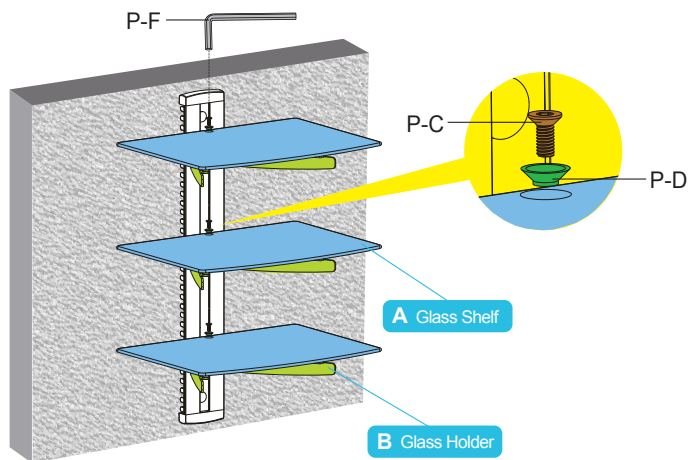

Attach the glass shelves to the glass holder using the plastic bushes (P-D), screws (P-C) and Allen Key (P-F)."

NOTE Tighten all screws but do not over tighten.

5 Cable Management

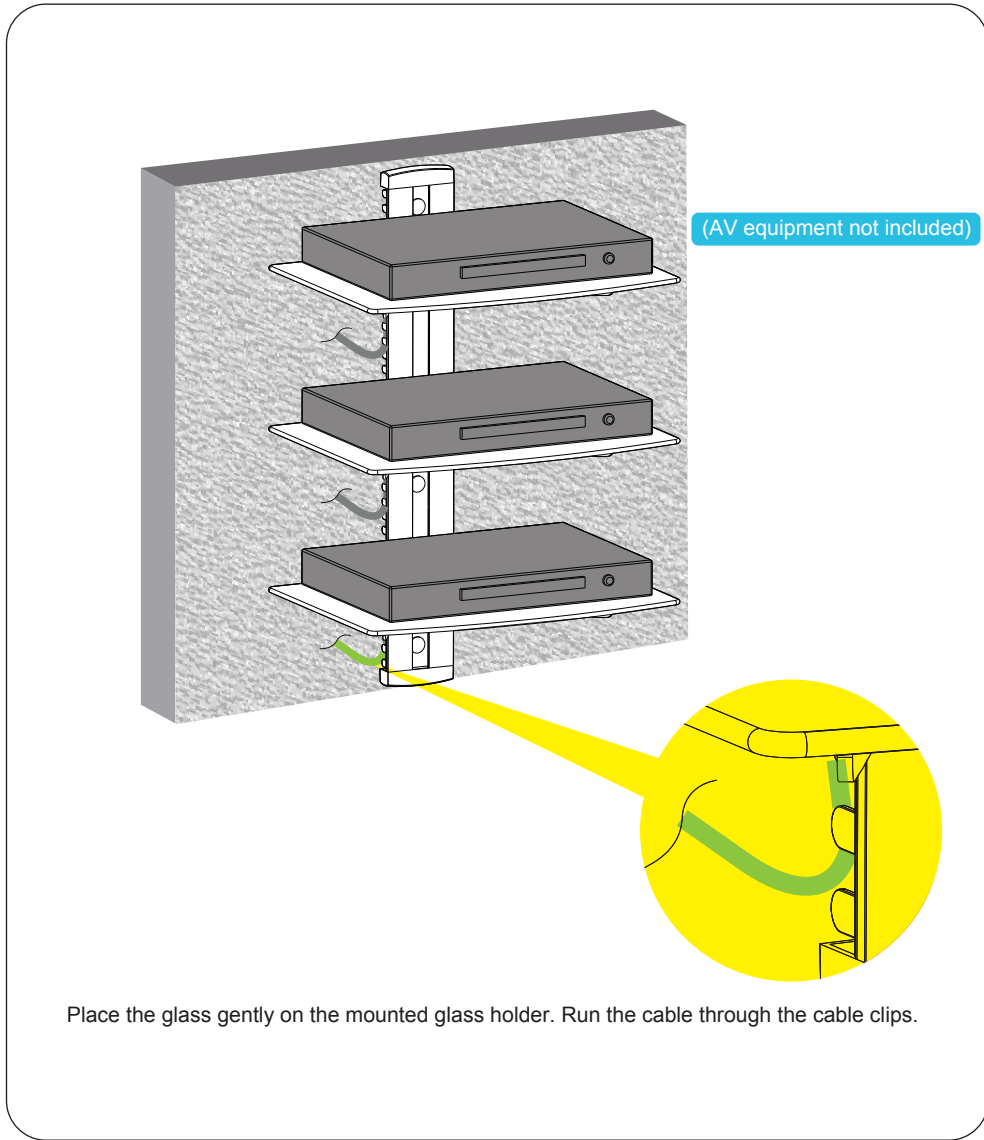

Place the glass gently on the mounted glass holder. Run the cable through the cable clips.